

# JACKOBOARD®

The construction board system for creative bathroom design.

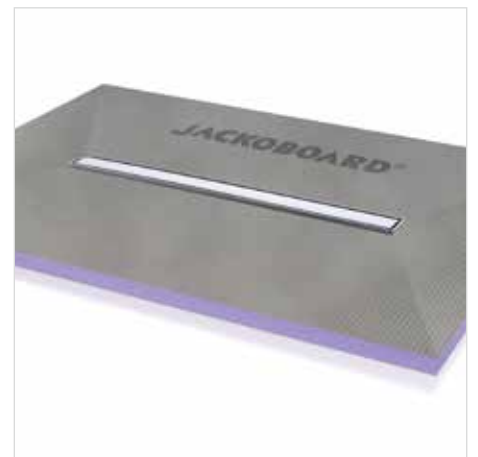



Easy to work with



Can be covered immediately with tiles, render or plaster



Waterproof



Truly light-weight approx. 3-6 kg/m<sup>2</sup>



Optimum insulation properties  $\lambda_D=0,034 \text{ W/(m}\cdot\text{K)}$



High compressive strength > 300 kPa



For rooms exposed to high levels of moisture (Wear class A1 and A2)

Thanks to their extruded polystyrene foam core and the special coating on both sides, the JACKOBOARD® construction boards are the ideal base for plaster, tile and render. The surfaces of the JACKOBOARD® system provide a strong primer and can be used on virtually any substrate. At the same time, they are waterproof, thermally insulating, truly light-weight and easy to install.



**JACKOBOARD®**  
The construction board system  
for creative bathroom design.

## Table of contents

### Construction board system

Plano	04
Flexo	05
Flexo-Plus	05
Canto	05
Wabo	07
Sabo self assembly set	08

### Bathroom furniture self assembly set

Wall shelf	08
Vanity	08
Modula D 800	09
Modula D 1600	09
Modula R 300	09
Modula R 600	09

### Steam and wetroom seating kits

Square edge style	11
Curved edge style	11
Curved edge with backrest	11

### Shower elements

J-Drain Linear	12
J-Drain Grating	12
Sloping Board	12
J-Drain Wall	13
J-Drain Wall Drain Sloping Board	13
Aqua Central	14
Aqua Quadrant	14
Aqua Offset	15
Aqua Flat	16
Aqua Flat Central	17
Aqua Base	17

Aqua drain systems	18
Stainless steel grates	19
Nova tileable drain cover	19
Aqua Line easy	20
Aqua Line easy drain systems	20
Aqua Line pro	21
Aqua Line pro drain systems	21
Aqua Line Profile	22
Aqua Reno	22
Aqua Delta	22
Panel	23
Aqua Circle	23
Aqua Spiral	25
Wall niches	26

### Fixing & Sealing Systems

Sealing set	27
Installation kit	27
Sealing kit	27
Waterproof membrane	28
Glass fibre tape 125	28
Sealing tape S/A	28
Sealing tape	29
Internal/External corners	29
Collars	29
BOARD-FIX® adhesive and sealing agent	29
Screws	30
Plastic washers	30
Galvanised Washers	30
Stainless steel washers	30
Anchor	31
Metal disk plugs	31
H-Profile	31
U-Profile	31
Technical specifications	32
Spares	33
Bespoke colours	33

# Construction board system

## JACKOBOARD® Plano

- Construction board for interior designs on walls and floor (wall, pipe and bath tub panelling, sink units, shelves etc.)
- Reinforced cement on both sides
- Can be covered directly with tiles, plaster or render
- No need to prime
- Waterproof
- Light-weight
- For more information please see page 32



Art. no.	EAN code	Thickness mm	Panel dim. mm
4511306	40 25345 09154 0	4	1200 x 600
4508150	40 25345 07013 2	6	1200 x 600
4508151	40 25345 07014 9	10	1200 x 600
4508152	40 25345 07015 6	12	1200 x 600
4508153	40 25345 07016 3	20	1200 x 600
4509364	40 25345 07904 5	30	1200 x 600
4509365	40 25345 07905 0	40	1200 x 600
4509366	40 25345 07906 7	50	1200 x 600
4509367	40 25345 07907 4	60	1200 x 600
4508126	40 25345 06992 1	10	2400 x 600
4508127	40 25345 06993 8	12	2400 x 600
4508128	40 25345 06994 5	20	2400 x 600
4508129	40 25345 06995 2	30	2400 x 600
4509369	40 25345 07909 8	40	2400 x 600
4509370	40 25345 07910 4	50	2400 x 600
4509371	40 25345 07911 1	60	2400 x 600
4511228	40 25345 09112 0	80	2400 x 600
4505061	40 25345 05061 5	12.5	2600 x 900



JACKOBOARD® Sealing Kit - Page 27



# Construction board system

## JACKOBOARD® Flexo

- Formable board for creative interior design
- Different radius finishes possible
- Can be covered directly with tiles, plaster or render
- Single-sided slotted surface
- Distance between slots 30 mm
- Smallest bending radius 240 mm (inner), Thickness 30 mm
- Smallest bending radius 480 mm (inner), Thickness 50 mm

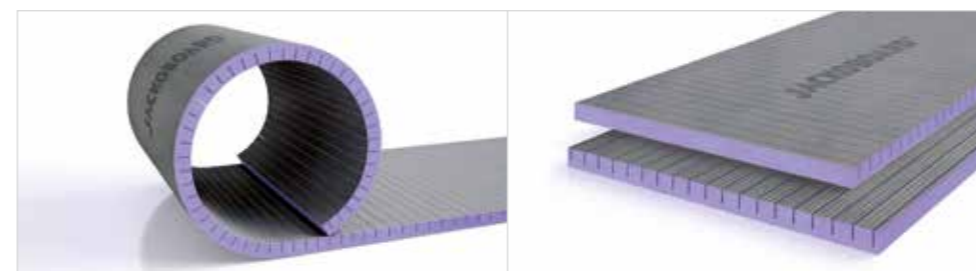

Art. no.	EAN code	Thickness mm	Panel dim. mm	Version
4502335	40 25345 02335 0	30	1300 x 600	crossw. slotted
4502362	40 25345 02362 6	30	2600 x 600	lengthw. slotted
4502929	40 25345 02929 1	50	1300 x 600	crossw. slotted
4502928	40 25345 02928 4	50	2600 x 600	lengthw. slotted

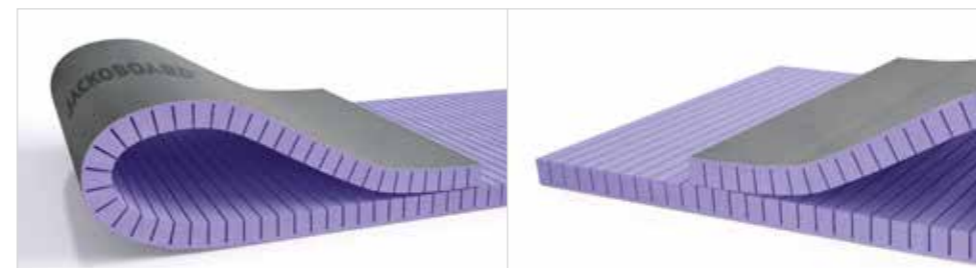
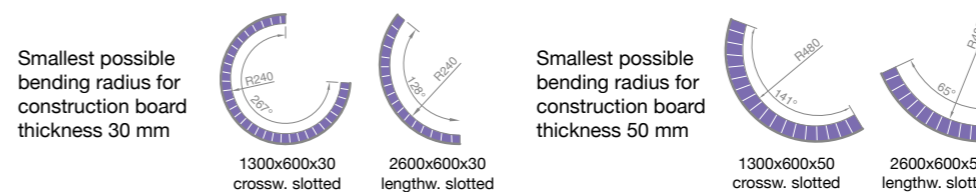

Art. no.	EAN code	Thickness mm	Panel dim. mm	Version
4507938	40 25345 06840 5	30	1300 x 600	crossw. slotted
4507939	40 25345 06841 2	30	2600 x 600	lengthw. slotted

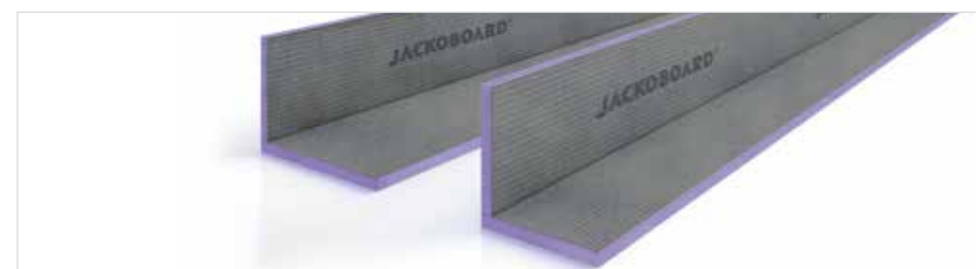
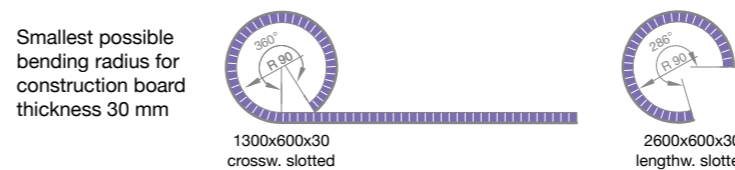

Art. no.	EAN code	Thickness mm	Length mm	Dimensions mm
4500043	40 25345 00043 6	20	2600	150 x 150
4500044	40 25345 00044 3	20	2600	200 x 200
4500009	40 25345 00009 2	20	2600	300 x 300
4500024	40 25345 00024 5	20	2600	400 x 200

## JACKOBOARD® Flexo-Plus

- Formable board for the creation of the widest possible variety of curves
- With a single-sided slotted surface
- Distance between slots 15 mm
- Specifically for small radii
- Smallest bending radius 90 mm (inner)
- Single-sided coating
- Can be covered directly with tiles, plaster or render

## JACKOBOARD® Canto - Pipe Cover

- Pre-fabricated element for angles and corners and to cover pipes
- Reinforced cement on both sides
- Can be supplied in U shape on request
- Can be covered directly with tiles, plaster or render

Waterproof,  
thermally insulating,  
truly light-weight  
and easy to install

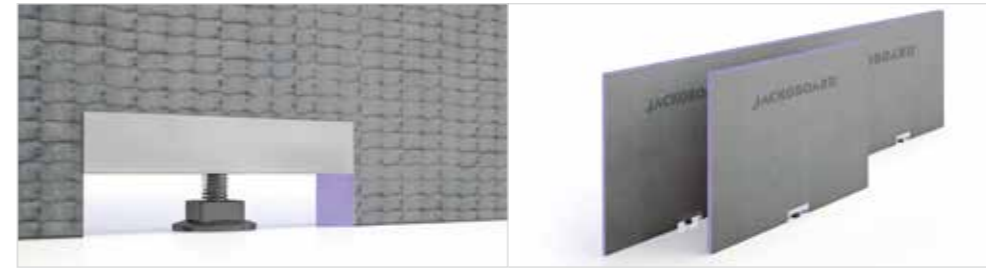

JACKOBOARD®  
Wabo bath panels

Art. no.	EAN code	Thickness mm	Panel dim. mm
4500032	40 25345 00032 0	30	2100 x 600
4513078	40 25345 10229 1	30	1850 x 600
4513079	40 25345 10230 7	30	850 x 600

- Bath panel for bathtub panelling
- Easy to install
- Reinforced cement on both sides
- Includes adjustable feet
- Can be covered directly with tiles, plaster or render



JACKOBOARD® Seating Kits - Page 11



## Construction board system

### JACKOBOARD® Sabo - WC wall clad self assembly set

- Assembly kit for cladding WC wall elements
- 2-part construction element with holes for installation of standard toilets, 10 self-cutting drilling-screws and 10 construction board disks included
- Special coating on both sides
- Can be covered directly with tiles, plaster or render

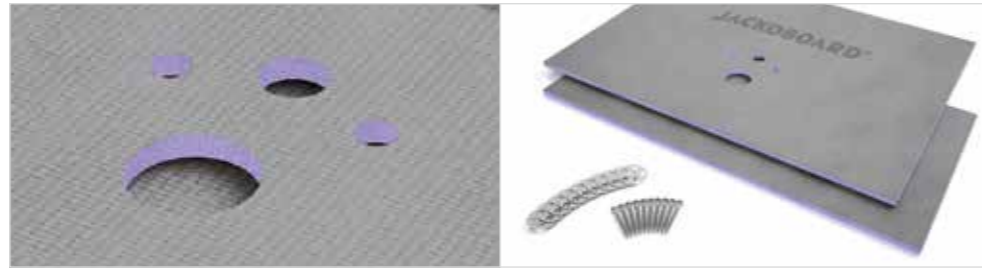

Art. no.	EAN code	Thickness mm	Panel dim. mm
4508472	40 25345 07242 6	20	1300 x 900 1300 x 600

### JACKOBOARD® Wall Shelf

- Tileable Wall Shelf for barrier free bathrooms
- Made from extruded rigid polystyrene foam coated with special mortar with fibre glass weave
- Incl. 2 solid wall brackets made of steel to create an impression of free floating



Art. no.	EAN code	Thickness mm	Dimensions mm
5008000	07 31628 45655 8	80	1200 x 600

### JACKOBOARD® Vanity

- Tileable designer washbasin for barrier-free bathrooms and spa facilities
- Made from extruded rigid polystyrene foam coated with special mortar with fibre glass weave
- Basin cutout with 3 fall surfaces
- With integrated moulded parts for mounting standard taps and drains
- Barrier-free in accordance with DIN 18040 parts 1 and 2
- Incl. 2 solid wall brackets made of steel to create an impression of free floating



Art. no.	EAN code	Thickness mm	Dimensions mm
4510565	40 25345 08690 4	110	1200 x 550

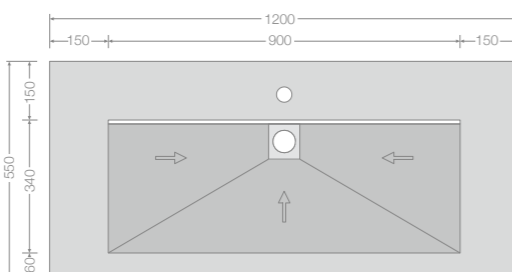

## Bathroom furniture self assembly set



Art. no.	EAN code	Width mm	Depth mm	Height mm
4506336	40 25345 05770 6	800	600	850

Bespoke sizes available on request



Art. no.	EAN code	Width mm	Depth mm	Height mm
4506335	40 25345 05769 0	1600	600	850

Bespoke sizes available on request



Art. no.	EAN code	Width mm	Depth mm	Height mm
4506338	40 25345 05772 0	600	300	2125

Bespoke sizes available on request



Art. no.	EAN code	Width mm	Depth mm	Height mm
4506337	40 25345 05771 3	600	600	2125

Bespoke sizes available on request

### JACKOBOARD® Modula D 800

- Assembly kit for single washstand consists of: 2 side walls and 1 top, 80 mm thick, 1 centre shelf, 50 mm thick, special adhesive, screws, mounting board, assembly instructions

### JACKOBOARD® Modula D 1600

- Assembly kit for double washstand consists of: 2 side walls, 1 centre wall and 1 top, 80 mm thick, 2 centre shelves, 50 mm thick, special adhesive, screws, mounting board, assembly instructions

### JACKOBOARD® Modula R 300

- Assembly kit for shelf unit consists of: 2 side walls and 5 shelves, 50 mm thick, special adhesive, screws, mounting board, assembly instructions

### JACKOBOARD® Modula R 600

- Assembly kit for shelf unit consists of: 2 side walls and 4 shelves, 50 mm thick, 1 shelf, 80 mm thick, special adhesive, screws, mounting board, assembly instructions

Create the perfect luxurious shower seating with our steam and wetroom seating kits

## Steam and wetroom seating kits

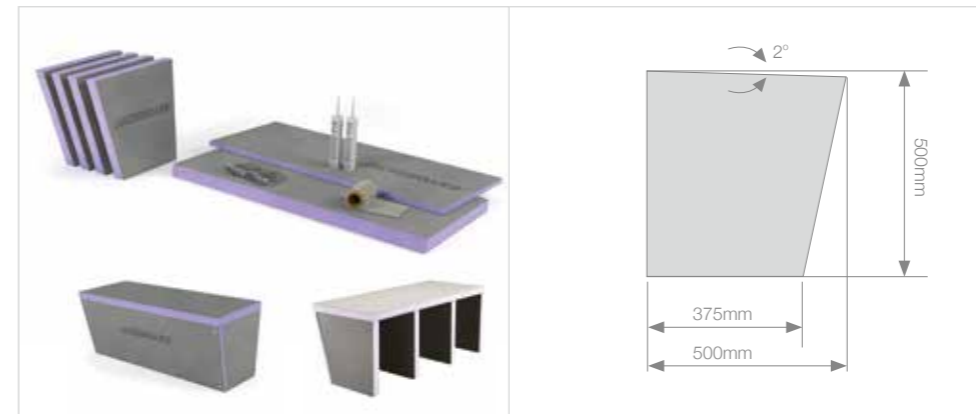

Art. no.	EAN code	Width mm	Depth mm	Height mm
5006010	07 31628 45656 5	1200	500	500

### JACKOBOARD® Square edge style

- 4 x 50 mm Profiled Vertical legs
- 1 x 50 mm Seat Top with pre-cut bevelled edge
- 1 x 20 mm Seat Front with pre-cut bevelled edge
- 2 x 290 ml BOARD-FIX Adhesive
- Screws and Washers to aid assembly whilst adhesive is curing
- Comprehensive assembly instructions

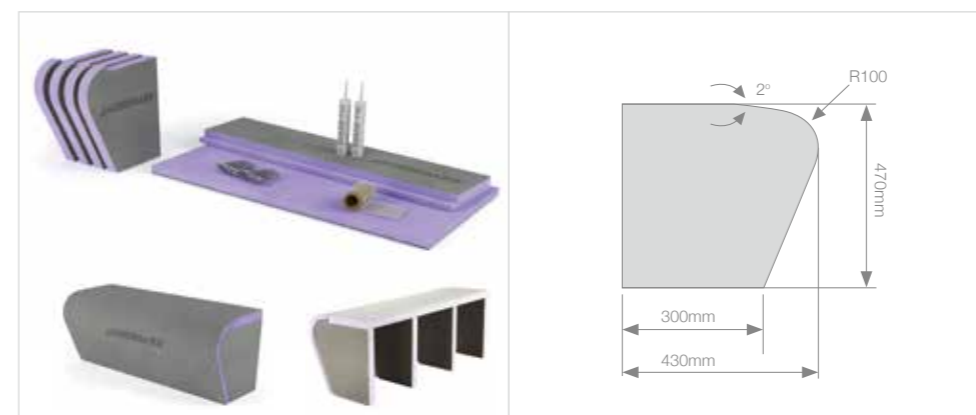

Art. no.	EAN code	Width mm	Depth mm	Height mm
5006020	07 31628 45657 2	1200	430	470

### JACKOBOARD® Curved edge style

- 4 x 50 mm Profiled Vertical legs
- 1 x 50 mm Seat Top
- 1 x 30 mm Flexo-Plus Seat Front
- 2 x 290 ml BOARD-FIX Adhesive
- Screws and Washers to aid assembly whilst adhesive is curing
- Comprehensive assembly instructions



Art. no.	EAN code	Width mm	Depth mm	Height mm
5006030	07 31628 45658 9	1200	590	845

### JACKOBOARD® Curved edge with backrest

- 4 x 50 mm Profiled Vertical legs
- 1 x Seat Back 1200 x 600 x 30 mm
- 1 x Seat Back 1200 x 210 x 30 mm
- 1 x Seat Support 1200 x 230 x 40 mm
- 1 x Back Support 1200 x 100 x 40 mm
- 1 x Seat Front Board 1200 x 300 x 30 mm
- 2 x Flexo-Plus Boards 1200 x 600 x 30 mm
- 3 x 290 ml BOARD-FIX Adhesive
- Screws and Washers to aid assembly whilst adhesive is curing
- Comprehensive assembly instructions

## J-Drain Linear Drain

### J-Drain Linear Drain

- Low Installation height
- Wide range of drain lengths
- Design led solution
- High drainage rate also available of 27.5 l/minute

### J-Drain Grating - Stainless Steel and Matt Black

- Height and depth adjustable
- Choice of drain finishes
- Different colours available on request (non-stock item)
- + Bespoke colours, please enquire

### JACKOBOARD® Sloping Board

- Unique Single-fall installation
- Simple Installation
- For use with J-Drain Linear

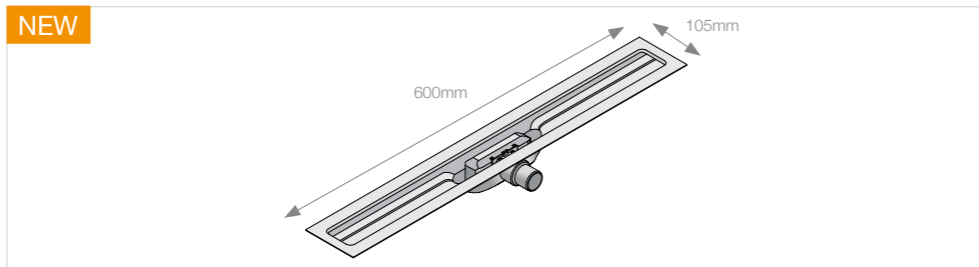

Art. no.	EAN code	Description
6000200	0731628456763	J-Drain linear drain, 600mm
6000210	0731628456770	J-Drain linear drain, 700mm
6000220	0731628456787	J-Drain linear drain, 800mm
6000230	0731628456794	J-Drain linear drain, 900mm
6000240	0716053614759	J-Drain linear drain, 1000mm
6000250	0716053614766	J-Drain linear drain, 1200mm



Art. no.	EAN code	Description
6000260	0716053614889	J-Drain grating - stainless steel 600mm
6000265	0716053614896	J-Drain grating - stainless steel 700mm
6000270	0716053614902	J-Drain grating - stainless steel 800mm
6000275	0716053614919	J-Drain grating - stainless steel 900mm
6000280	0716053614926	J-Drain grating - stainless steel 1000mm
6000285	0716053614933	J-Drain grating - stainless steel 1200mm
6000300	0716053614773	J-Drain grating - matt black 600mm
6000310	0716053614780	J-Drain grating - matt black 700mm
6000320	0716053614797	J-Drain grating - matt black 800mm
6000330	0716053614803	J-Drain grating - matt black 900mm
6000340	0716053614810	J-Drain grating - matt black 1000mm
6000350	0716053614827	J-Drain grating - matt black 1200mm

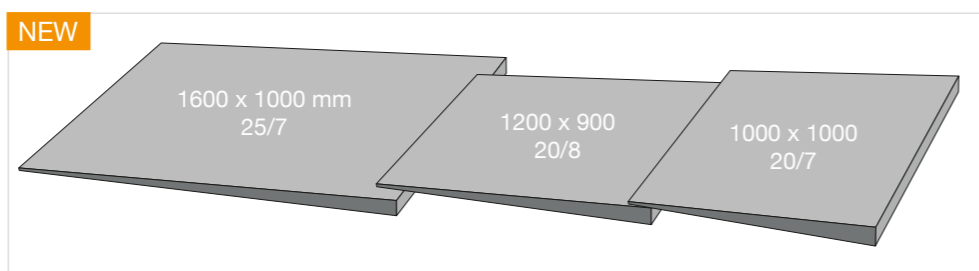

Art. no.	EAN code	Description
4512765	0716053615022	JACKOBOARD® Sloping Board 1200 x 900 x 20/8
4519012	0716053615039	JACKOBOARD® Sloping Board 1000 x 1000 x 20/7
4519011	0716053615046	JACKOBOARD® Sloping Board 1600 x 1000 x 25/7

## J-Drain Wall Drain

### J-Drain Wall Drain

- Choice of connection positions
- Low Installation height
- Adjustable position of drain body
- Design led solution
- High drainage rate of 27.5 l/minute
- J-Drain Wall LED, Price on Application (non-stock item)



Art. no.	EAN code	Description
6000400	0716053614940	J drain wall
6000410	0716053614964	J-Drain wall drain cover plate - 10mm tiles, tileable
6000420	0716053614971	J-Drain wall drain cover plate - 10mm tiles, stainless
6000430	0716053614988	J-Drain wall drain cover plate - 17mm tiles, stainless

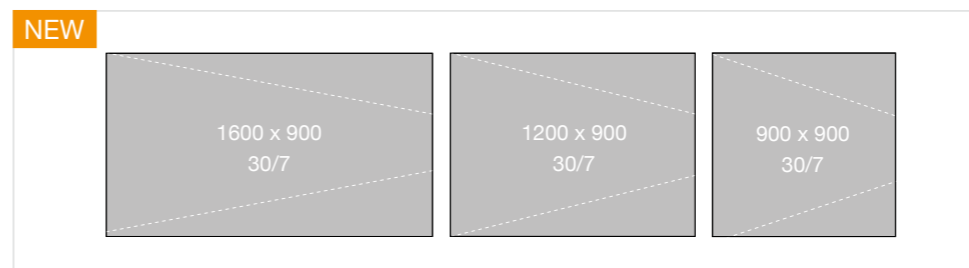

Art. no.	EAN code	Description
4520089	0716053614995	J-Drain wall drain sloping board 1600 x 900 x 30/7
4520090	0716053615008	J-Drain wall drain sloping board 1200 x 900 x 30/7
4520091	0716053615015	J-Drain wall drain sloping board 900 x 900 x 30/7

### J-Drain Wall Drain Sloping Board

- Unique installation with three falls to drain
- Simple Installation
- For use with J-Drain Wall

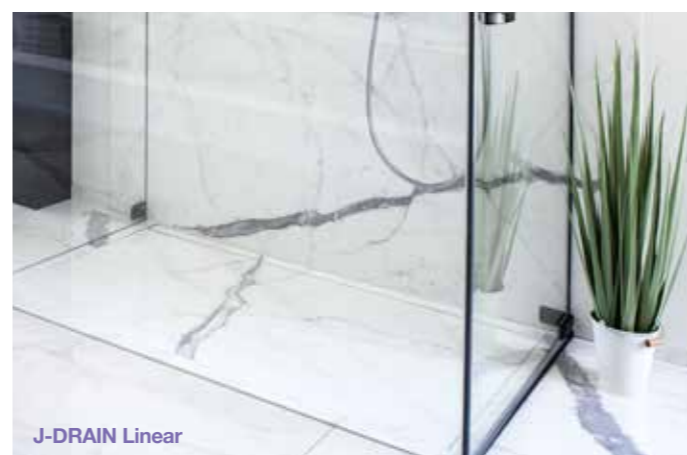

\*Price available on request

## Shower elements - Pre-formed falls

### JACKOBOARD® Aqua central drain

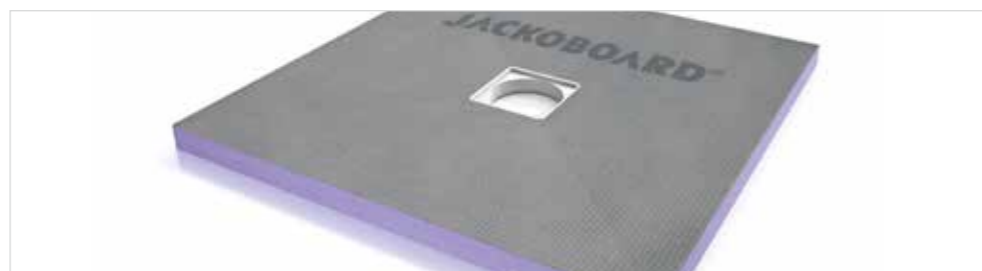

Art. no.	EAN code	! Thickness mm	Panel dim. mm
4512286	40 25345 09807 5	40	800 x 800
4512087	40 25345 09725 2	40	900 x 900
4512088	40 25345 09726 9	40	1000 x 1000
4512090	40 25345 09728 3	40	1200 x 1200
4512131	40 25345 09751 1	40	1500 x 1500
4512089	40 25345 09727 6	40	1200 x 900
4512091	40 25345 09729 0	40	1800 x 900

#### Special dimensions:

In addition to the standard sizes, JACKOBOARD® Aqua is also available in a wide range of made-to-measure sizes and shapes on request.



Art. no.	EAN code	! Thickness mm	Panel dim. mm	Drain centre from the edge
4512122	40 25345 09747 4	40	900 x 900	250 / 250

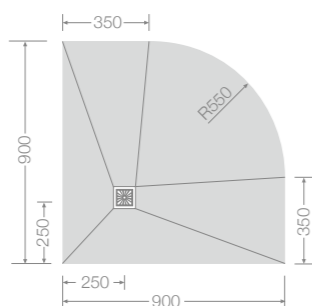

- Extruded polystyrene foam shower element with special coating on both sides
- For barrier-free showering
- Can be tiled immediately
- Pre-formed falls
- Sealed drain flange
- Wheelchair-accessible when element is tiled
- Waterproof
- Choice of different drainage systems (see pages 18-19)**

! Generally for use with solid floors

- Extruded polystyrene foam shower element with special coating on both sides
- For barrier-free showering
- Can be tiled immediately
- Pre-formed falls
- Sealed drain flange
- Wheelchair-accessible when element is tiled
- Choice of different drainage systems (see pages 18-19)**

! Generally for use with solid floors

## Shower elements - Pre-formed falls

### JACKOBOARD® Aqua offset drain

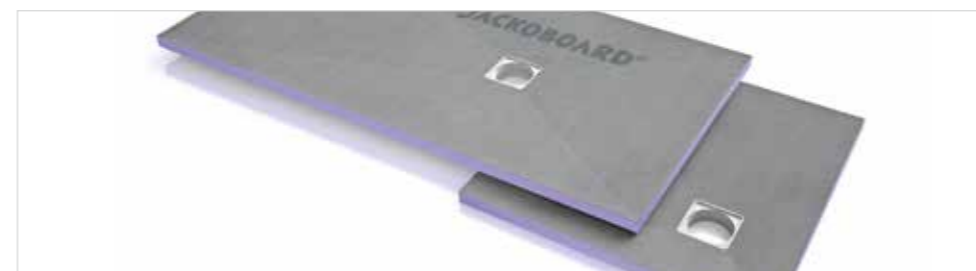

Art. no.	EAN code	! Thickness mm	Panel dim. mm	Drain centre from the edge
4512092	40 25345 09730 6	40	900 x 900	250 / 250
4512093	40 25345 09731 3	40	1000 x 1000	250 / 250
4512095	40 25345 09733 7	40	1200 x 1200	350 / 350
4512094	40 25345 09732 0	40	1200 x 900	250 / 450
4512096	40 25345 09734 4	40	1400 x 900	450 / 450
4512097	40 25345 09735 1	40	1500 x 900	450 / 450
4512098	40 25345 09736 8	40	1800 x 900	650 / 450
4512099	40 25345 09737 5	50	1800 x 900	450 / 450
4512100	40 25345 09738 2	50	2000 x 1000	500 / 500

- Extruded polystyrene foam shower element with special coating on both sides
- For barrier-free showering
- Can be tiled immediately
- Pre-formed falls
- Sealed drain flange
- Wheelchair-accessible when element is tiled
- Choice of different drainage systems (see pages 18-19)**

! Generally for use with solid floors

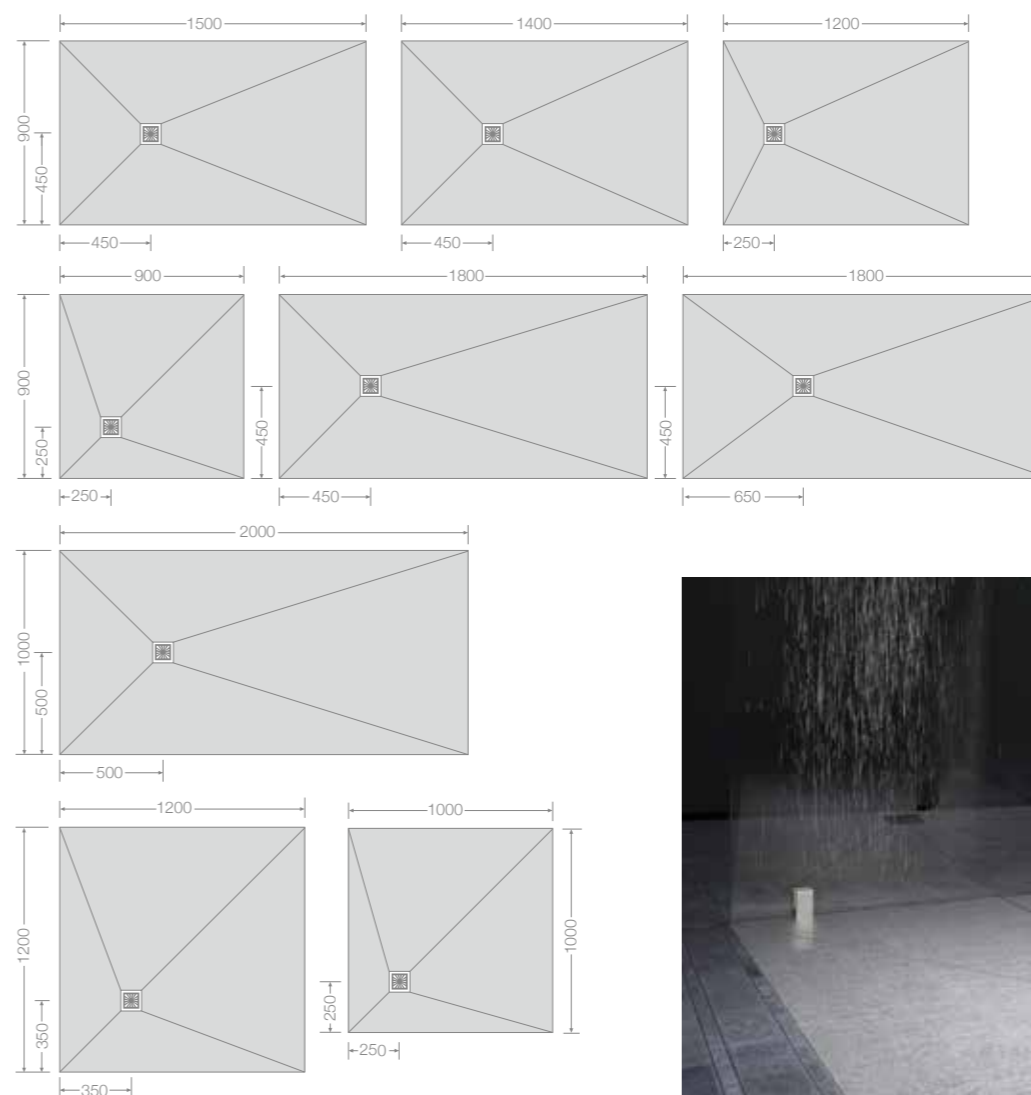

# Shower elements - Pre-formed falls

## JACKOBOARD® Aqua Flat offset drain



Art. no.	EAN code	✓ Thickness mm	Panel dim. mm	Drain centre from the edge
4512292	40 25345 09812 9	20	1000 x 1000	300 / 300
4512293	40 25345 09813 6	20	1200 x 900	450 / 450
4512357	40 25345 09916 4	20	1200 x 900	600 / 300
4512359	40 25345 09917 1	20	1300 x 800	650 / 300
4512295	40 25345 09815 0	25	1500 x 800	450 / 400
4512360	40 25345 09918 8	25	1800 x 900	900 / 300

Bespoke sizes available on request

- Low profile version, just 20 mm or 25 mm thick
- Pre-formed falls
- Choice of different drainage systems (see pages 18-19)
- Specifically developed for installation on suspended timber floors

# Shower elements - Pre-formed falls



Art. no.	EAN code	✓ Thickness mm	Panel dim. mm	Drain position
4512290	40 25345 09810 5	20	800 x 800	central
4512101	40 25345 09739 9	20	900 x 900	central
4512291	40 25345 09811 2	20	1000 x 1000	central
4512103	40 25345 09741 2	20	1200 x 1200	central
4512102	40 25345 09740 5	20	1200 x 900	central
4512294	40 25345 09814 3	20	1800 x 900	central
4512458	40 2534 509951 5	25	1500 x 1500	central

Bespoke sizes available on request

## JACKOBOARD® Aqua Flat central drain

- Low profile version, just 20 mm thick
- Pre-formed falls
- Choice of different drainage systems (see page 18-19)
- Specifically developed for installation on suspended timber floors

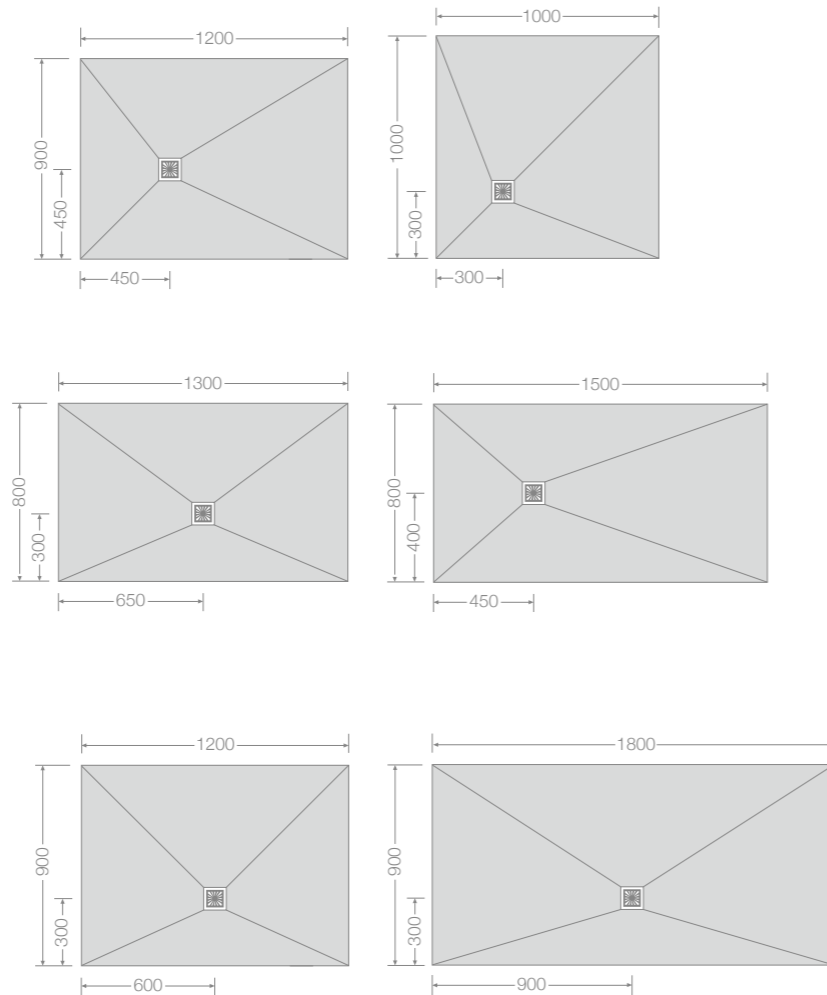

Art. no.	EAN code	Thickness mm	Dimensions mm
4512048	40 25345 09695 8	80	900 x 900
4512049	40 25345 09696 5	50	1200 x 1200
4512050	40 25345 09697 2	80	1200 x 1200
4512051	40 25345 09698 9	50	1800 x 900
4512052	40 25345 09699 6	80	1800 x 900

Bespoke sizes available on request

## JACKOBOARD® Aqua base

- Element to raise JACKOBOARD® Aqua to the required level
- Fast and economical to handle
- Perforations for different drain positions
- Quick and easy solution

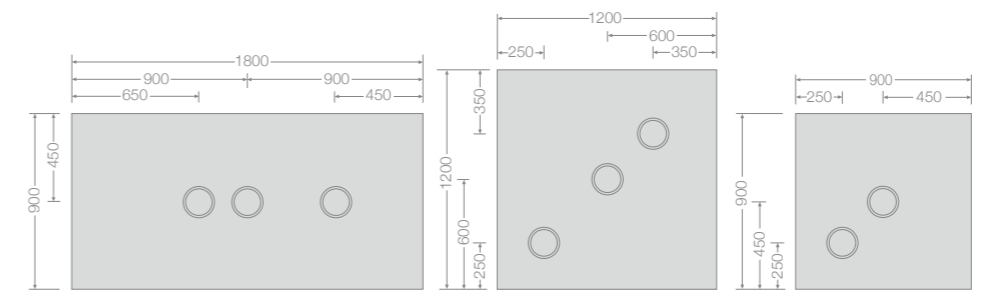

JACKOBOARD®  
Aqua drain systems

Suitable for Aqua, Aqua Quadrant  
& Aqua Flat Shower Elements



Horizontal drain

- High-quality designer grate in solid brushed stainless steel
- Grate frame height adjustable from 3 to 18 mm
- Super-flat drain with a minimum installation height including shower element of only 97 mm
- High drainage rate 0.9 l/s
- Water trap height 50 mm
- DN 50
- Drain nozzle made of glueable ABS plastic

✓ For more information, see page 34

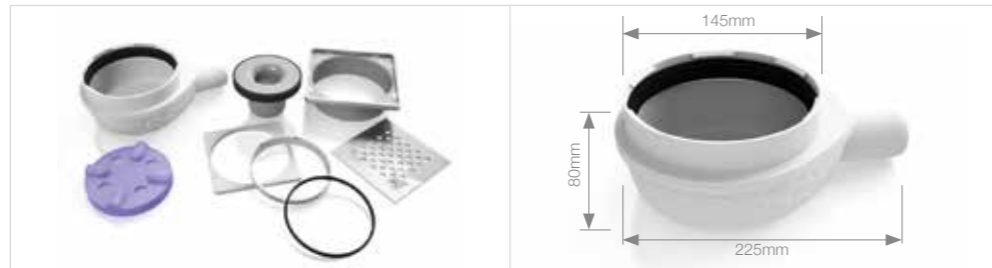

Art. no.	EAN code
4512007	40 25345 09478 7

Vertical drain

- High-quality designer grate in solid brushed stainless steel
- Grate frame height adjustable from 3 to 18 mm
- High drainage rate 0.9 l/s
- Water trap height 50 mm
- DN 40/50
- Drain nozzle made of glueable ABS plastic

✓ For more information, see page 34



Art. no.	EAN code
4512008	40 25345 09479 4

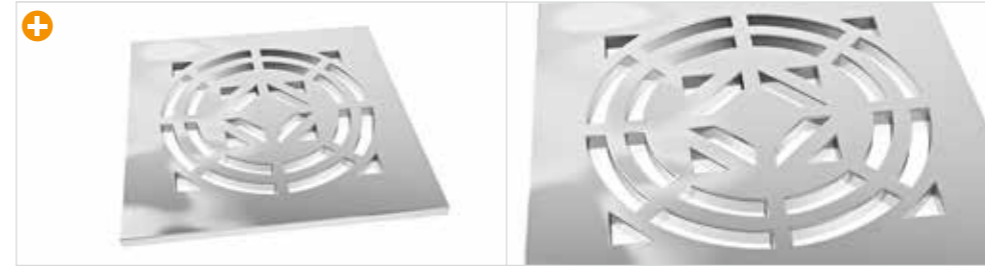

Art. no.	EAN code	Thickness mm	Dimensions mm
4512135	40 25345 09482 4	4	120 x 120

JACKOBOARD®  
Terra  
stainless steel grate

- In solid stainless steel
- Brushed surface
- ⊕ Bespoke colours, please enquire

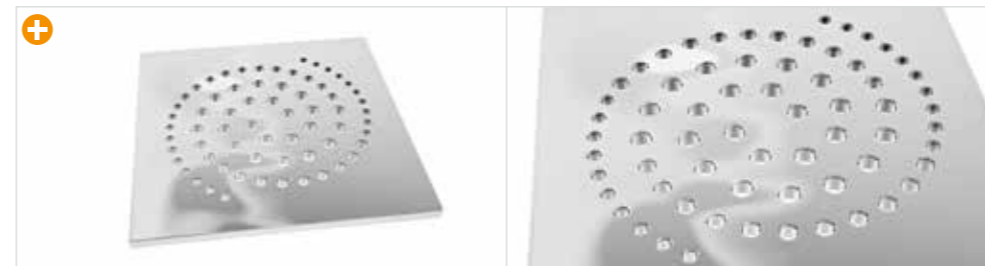

Art. no.	EAN code	Thickness mm	Dimensions mm
4512137	40 25345 09484 8	4	120 x 120

JACKOBOARD®  
Stella  
stainless steel grate

- In solid stainless steel
- Brushed surface
- ⊕ Bespoke colours, please enquire



Art. no.	EAN code	Thickness mm	Dimensions mm
4512136	40 25345 09483 1	4	120 x 120

JACKOBOARD®  
Sol  
stainless steel grate

- In solid stainless steel
- Brushed surface
- ⊕ Bespoke colours, please enquire



Art. no.	EAN code	Height mm	Dimensions mm
4512138	40 25345 09485 5	90	130 x 130

JACKOBOARD®  
Nova  
tileable drain cover

- Tileable drain cover to replace steel grate
- Tileable tray in stainless steel
- Tray edged with stainless steel upstand
- Suitable for tiles with thicknesses from 8 mm

JACKOBOARD®  
Aqua Line easy

- Shower element with brushed stainless steel drain channel
- Fixed grate height of 15 mm
- Stainless steel linear grate can be reversed and tiled
- Bar and frame made of stainless steel
- Smooth, easy-clean surface with self-cleaning effect
- Low installation height
- Water trap height: 22 mm
- Specifically developed for installation on suspended timber floors
- Bespoke colours of grate, please enquire

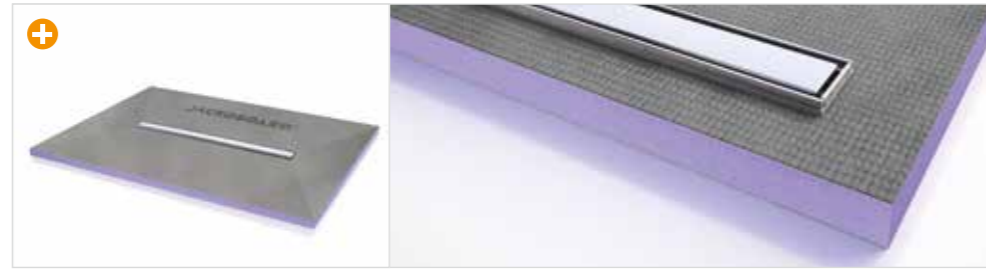

1-sided fall (see drawing)

Art. no.	EAN code	Thickness mm	Channel width mm	Drain position	Length x width mm
4510707	40 25345 08776 5	40/25	750	end	1200 x 900

4-sided fall (see drawing)

Art. no.	EAN code	Thickness mm	Channel width mm	Drain position	Length x width mm
4513791	40 25345 10648 0	30	300	end	900 x 900
4517481	40 25345 12648 8	30	550	end	1200 x 900
4517459	40 25345 12641 9	30	550	end	1600 x 900
4517461	40 25345 12643 3	30	550	central	1200 x 900
4517485	40 25345 12649 5	30	550	edge	1800 x 900

Bespoke sizes available on request

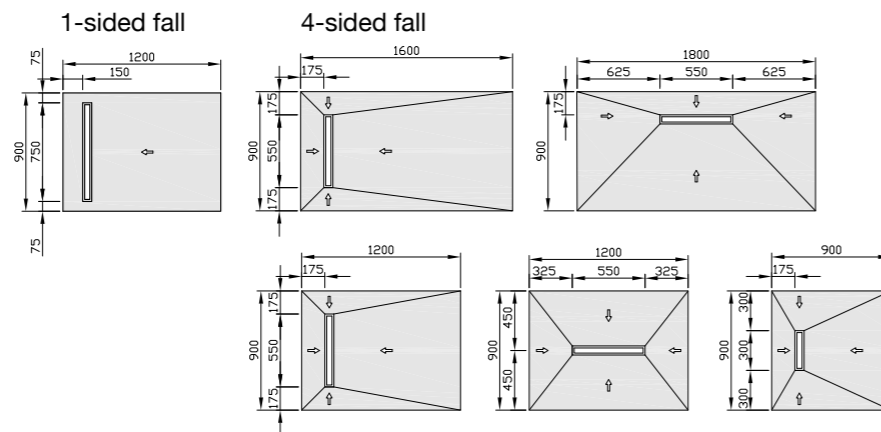

JACKOBOARD®  
Aqua Line easy  
drain systems

- Horizontal drain**
- Fits JACKOBOARD® Aqua Line easy
  - Height: 90 mm
  - DN 50
  - Drainage rate of up to 0.6 l/s
- Vertical drain**
- Fits JACKOBOARD® Aqua Line easy
  - Height: 140 mm
  - Thickness: 156 mm
  - DN 50/40
  - Drainage rate of up to 0.6 l/s



Art. no.	EAN code
4515478	40 25345 11256 6
Art. no.	EAN code
4515479	40 25345 11257 3

JACKOBOARD®  
Aqua Line pro

- Shower element with drainage channel in brushed stainless steel
- Frame height is adjustable from 6-21 mm to accommodate different tile thicknesses
- Stainless steel linear grate can be reversed and tiled
- Bar and frame made of stainless steel
- Smooth, easy-clean surface with self-cleaning effect
- Water trap height 50 mm
- Generally for use with solid floors
- Bespoke colours of grate, please enquire

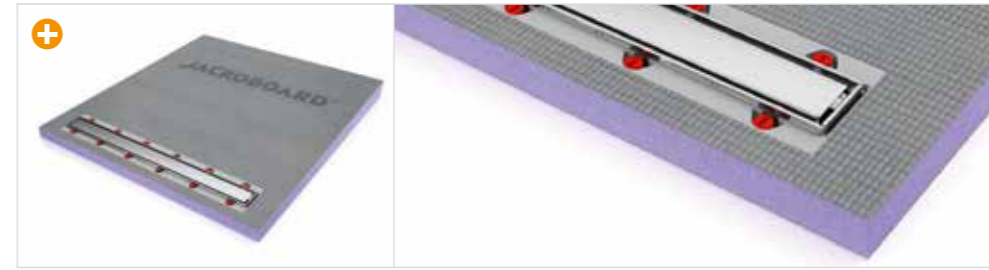

1-sided fall (see drawing)

Art. no.	EAN code	Thickness mm	Channel width mm	Length x Width mm	Drain position
4510330	40 25345 08514 3	60/43	750	1000 x 900	end
4510331	40 25345 08515 0	70/43	850	1100 x 1000	end
4510333	40 25345 08517 4	70/43	750	1400 x 900	end
4510336	40 25345 08520 4	80/43	750	1800 x 900	end
4510332	40 25345 08516 7	70/43	950	1200 x 1100	end
4510334	40 25345 08518 1	70/43	1150	1400 x 1300	end

4-sided fall (see drawing)

Art. no.	EAN code	Thickness mm	Channel width mm	Length x Width mm	Drain position
4510335	40 25345 08519 8	60	950	1600 x 1000	edge

Bespoke sizes available on request

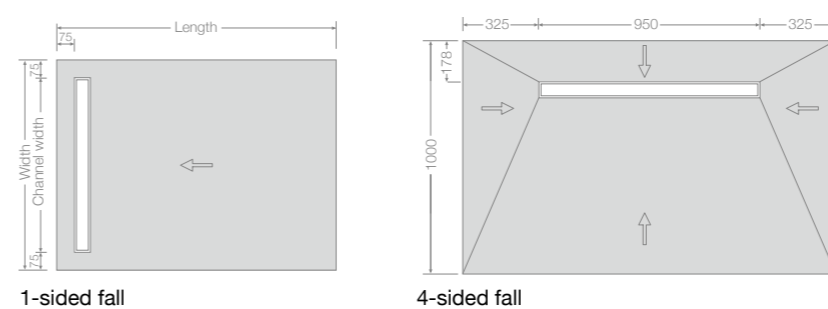

Art. no.	EAN code
4510370	40 25345 08560 0
Art. no.	EAN code
4510371	40 25345 08561 7

JACKOBOARD®  
Aqua Line pro  
drain systems

- Horizontal drain**
- Fits JACKOBOARD® Aqua Line pro
  - Height: 70 mm
  - DN 50
  - High drainage rate of up to 1.05 l/s
- Vertical drain**
- Fits JACKOBOARD® Aqua Line pro
  - Height: 192 mm
  - Thickness: 156 mm
  - DN 50
  - High drainage rate of up to 1.05 l/s

# Shower elements

## JACKOBOARD® Aqua Line Profile

- Accessory for JACKOBOARD® Aqua Line pro
- Side edge profile for insertion between JACKOBOARD® Aqua Line pro and the screed
- Edge with 2 % falls to match the JACKOBOARD® Aqua Line pro
- Track made of brushed stainless steel



Art. no.	EAN code	Length mm	Upstand in mm	Version*
4506484	40 25345 05856 7	1480	10	right
4506485	40 25345 05857 4	1480	10	left
4511939	40 25345 09474 9	2000	10	right
4511940	40 25345 09475 6	2000	10	left

\*Model on the left

## JACKOBOARD® Aqua Reno

- Shower element with integrated drainage system and inspection chamber element
- Barrier-free system solution for existing buildings
- Minimum installation height only 65 mm
- Including special adhesive and 10 m sealing tape for sealing joints
- Pre-formed falls
- Integrated floor drain
- Can be tiled immediately
- Drainage rate: 0.5 l/s
- Water trap height: 22 mm
- Including a high-quality designer grate in solid brushed stainless steel



Art. no.	EAN code	Thickness mm	Panel dim. mm	Drain centre from the edge
4512256	40 35345 09790 0	65	900 x 900	450 / 450
4512257	40 35345 09791 7	65	1400 x 900	450 / 450
4512258	40 35345 09792 4	75	1800 x 900	450 / 450

Bespoke sizes available on request

## JACKOBOARD® Aqua Delta

- Shower element with corner drain for barrier-free showers
- Height-adjustable grate made of brushed stainless steel
- Sealed stainless steel flange with edge that can be tiled over
- Pre-formed falls
- Special sizes available on request
- Can be covered directly with tiles
- Incl. horizontal drain system

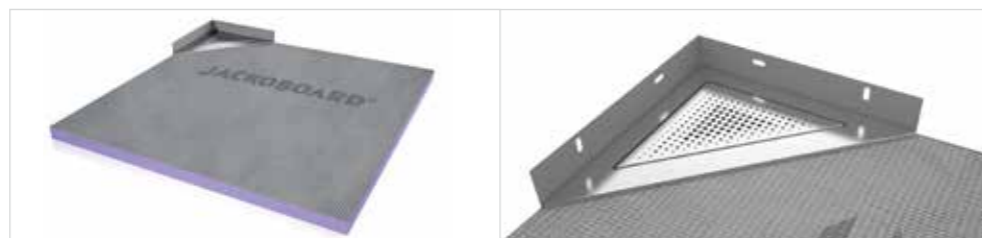

Art. no.	EAN code	Thickness mm	Dimensions mm
4506488*	40 25345 05860 4	50	900 x 900
4506489*	40 25345 05861 1	50	1200 x 1200

\*on request

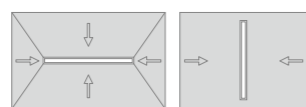

JACKOBOARD® Aqua Line pro

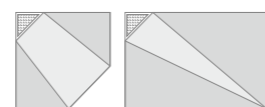

JACKOBOARD® Aqua Delta



Art. no.	EAN code	Thickness mm	Length mm	Width mm
4505094*	40 25345 05094 3	32	2200	345

\*on request



Art. no.	EAN code	Thickness mm	Height mm
4503176*	40 25345 03176 8	50	2150

\*on request

Art. no.	EAN code	Thickness mm	Dimensions mm
4512104*	40 25345 09742 9	40	1200 x 1200

\*on request

## JACKOBOARD® Panel

- Panel for mounting taps, shower heads and piping to complete JACKOBOARD® Aqua Circle and Aqua Spiral
- With Pre-formed reinforcement plate and cut-out section at the back for pipes
- Curve radius  $r = 500$  mm
- Special sizes available on request
- Can be covered directly with tiles

## JACKOBOARD® Aqua Circle

### Shower partition wall

- Shower partition wall consisting of 5 elements with tongue and groove connection
- Inside wall surface approx. 5.82 m<sup>2</sup>
- Outside wall surface approx. 6.39 m<sup>2</sup>
- Special dimensions possible on request
- Can be tiled immediately

### Floor element

- Barrier-free shower element with Pre-formed falls
- Internal diameter 1000 mm
- External diameter 1100 mm
- Groove for insertion of partition elements
- Inside floor surface approx. 0.8 m<sup>2</sup>
- Choice of different drainage systems (see page 18)

Make a statement with JACKOBOARD® Aqua Spiral

## Shower elements

JACKOBOARD® Aqua Spiral



Art. no.	EAN code	Thickness mm	Height mm	Version
4511717*	40 25345 09444 2	50	2150	entrance left
4511719*	40 25345 09446 6	50	2150	entrance right

\*on request

### Shower partition

- Curved Shower in the shape of an Archimedes spiral
- Outer dimensions 2055 x 1696 mm
- Height 2150 mm
- Thickness 50 mm
- Consisting of separate partition walls with groove and feather connections
- Inside wall surface approx. 10.7 m<sup>2</sup>
- Outside wall surface approx. 11.4 m<sup>2</sup>

Art. no.	EAN code	Thickness mm	Dimensions mm	Version
4512106*	40 25345 09746 7	50	2055 x 1696	entrance right
4512105*	40 25345 09743 6	50	2055 x 1696	entrance left

\*on request

### Floor element

- Barrier-free shower element with pre-formed falls
- Groove for insertion of partition elements
- Thickness 50 mm
- Inside floor surface approx. 2.1 m<sup>2</sup>
- Curved shower available in other sizes on request
- Drain system included
- Can be covered directly with tiles
- **Choice of different drainage systems (see page 18)**

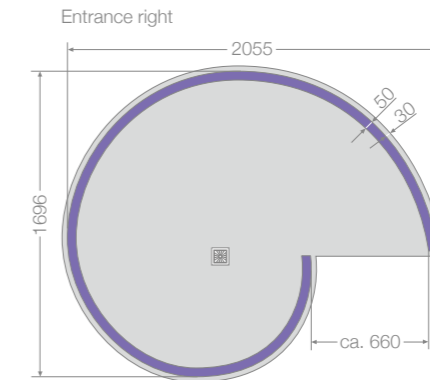
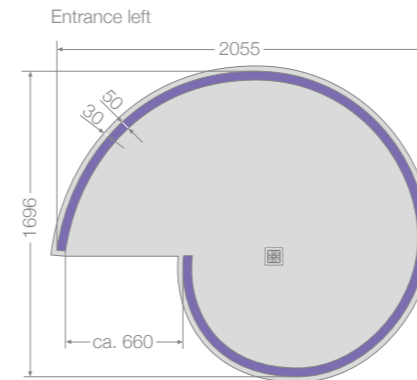

**JACKOBOARD®**  
Wall niches



Art. no.	EAN code	Description
5009010	0731628456305	Wall Niche 350 x 250 x 100
5009020	0731628456312	Wall Niche 350 x 250 x 150
5009030	0731628456329	Wall Niche 350 x 350 x 100
5009040	0731628456336	Wall Niche 350 x 350 x 150
5009050	0731628456343	Wall Niche 350 x 450 x 100
5009060	0731628456350	Wall Niche 350 x 450 x 150
5009070	0731628456367	Wall Niche 350 x 1600 x 150

- An elegant way to create more storage space in your bathroom
- ability to enhance your bathroom design and provide new spaces to stow all your shampoos, shower gels and other bathroom items
- Available in various sizes and depths
- Boxed individually

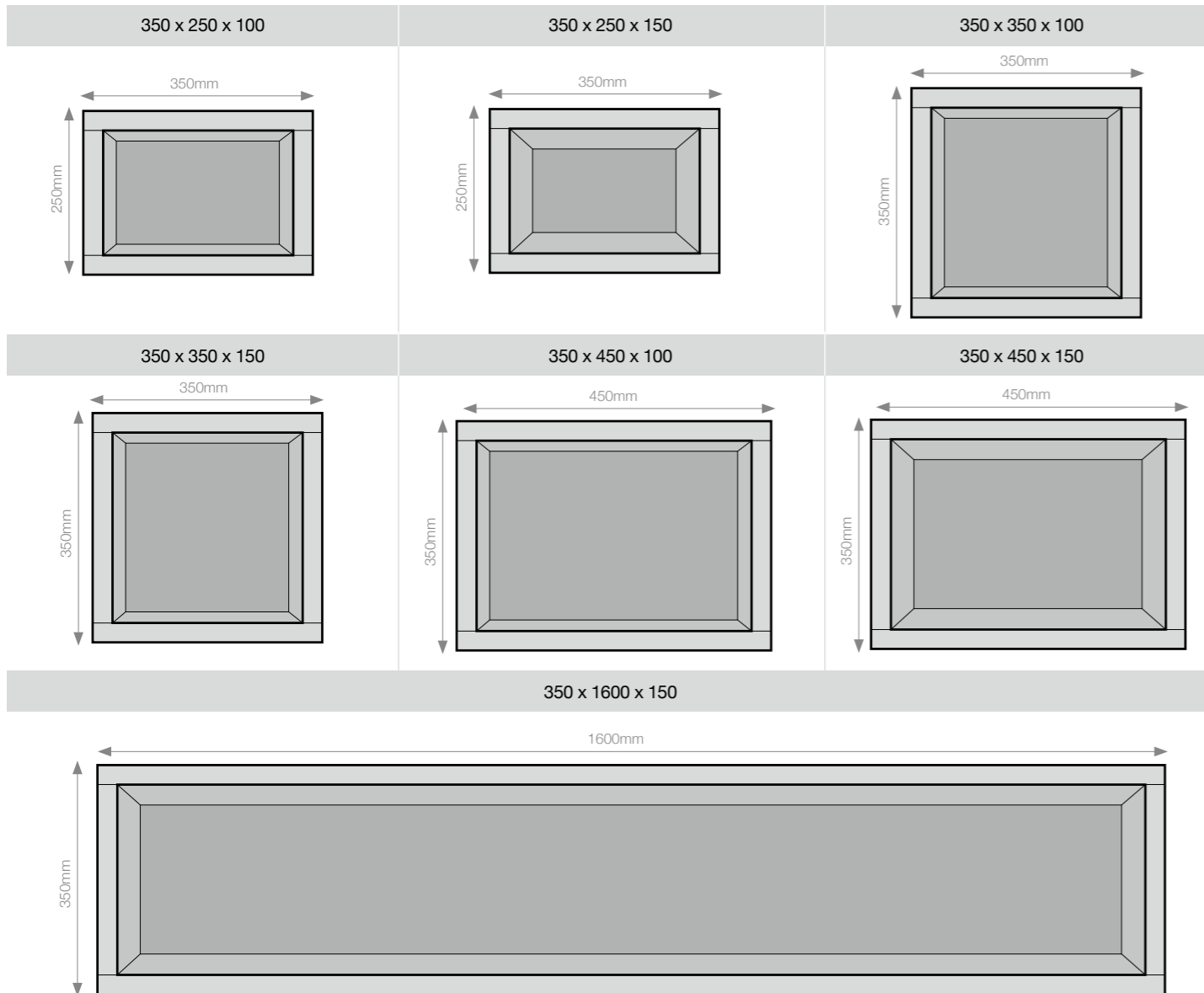

Art. no.	EAN code
4504509	40 25345 04509 3

**JACKOBOARD® 2K**  
Sealing set

- For joint seals in shower areas and steam rooms
- Sealing set consisting of 1x powder component, 1x liquid component, 10 m sealing tape, 2 x sealing corners



Art. no.	EAN code	Description
5004000	07 31628 45669 5	JACKOBOARD® Aqua Installation Kit - Horizontal
5004010	07 31628 45670 1	JACKOBOARD® Aqua Installation Kit - Vertical
5004020	07 31628 45671 8	JACKOBOARD® Aqua Line Easy Installation Kit - Horizontal
5004030	07 31628 45672 5	JACKOBOARD® Aqua Line Easy Installation Kit - Vertical
5004040	07 31628 45673 2	JACKOBOARD® Aqua Line Pro Installation Kit - Horizontal
5004050	07 3162845674 9	JACKOBOARD® Aqua Line Pro Installation Kit - Vertical

**JACKOBOARD®**  
Installation kit

- Easy to use installation kit for the Aqua Flat, Aqua Line Easy and Aqua Line Pro shower elements
- 5 kg Adhesive to bond base to substrate
- 1 litre primer to prime timber and plasterboard surfaces
- Waterproofing membrane sufficient to fix the sealing tape and corners
- 10 m sealing tape
- Includes suitable drain
- 2 x pre-formed corner seals

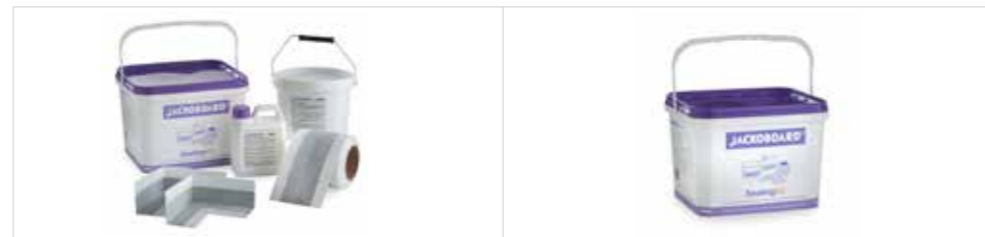

Art. no.	EAN code
5004450	07 31628 45654 1

**JACKOBOARD®**  
Sealing kit

- JACKOBOARD® Sealing Kit for domestic or light commercial shower/wet areas
- 1 litre primer to prime timber and plasterboard surfaces
- Waterproofing membrane sufficient to fix the sealing tape and corners
- 10 m sealing tape
- 2 x internal pre-formed corner seals

**JACKOBOARD®**  
Waterproofing  
Membrane

- For completely watertight joint seals in shower areas
- Used in conjunction with JACKOBOARD® sealing tape the paste provides a complete water proof seal for joints between Shower Elements and Plano boards



Art. no.	EAN codes	Weight	Coverage
5003020	07 31628 45661 9	7.5kg	8m <sup>2</sup>
5003030	07 31628 45663 3	1 litre primer	n/a

**JACKOBOARD®**  
Glass fibre tape 125

- For reinforcing the abutting edges of JACKOBOARD® Plano
- Self-adhesive
- For use in dry areas



Art. no.	EAN code	Width mm	Roll length m
4520005	40 25345 10279 6	125	25

**JACKOBOARD®**  
Sealing tape -  
self adhesive

- For reinforcing the abutting edges of JACKOBOARD® elements in wet areas
- Self-adhesive



Art. no.	EAN-Code	Width mm	Roll length m
5001000	0731628456640	80	20

**JACKOBOARD®**  
Sealing Internal and  
External Corner - self  
adhesive

- Prefabricated corners for sealing JACKOBOARD® elements in wet areas
- Self-adhesive



Art. no.	EAN-Code	Width mm	Description
5001010	0731628456657	70	S/A Internal Corner
5001030	0731628456664	70	S/A External Corner

**JACKOBOARD®**  
Sealing tape

- For sealing the abutting edges of JACKOBOARD® elements and Plano in wet areas
- With a central rubber coating
- Non Self-Adhesive therefore apply with JACKOBOARD® sealing waterproofing membrane



Art. no.	EAN code	Width mm	Roll length m
4500058	40 25345 00058 0	120	50
4501715	40 25345 01715 1	120	10

**JACKOBOARD®**  
Internal and  
External Corner

- Prefabricated corners for sealing JACKOBOARD® elements and Plano in wet areas

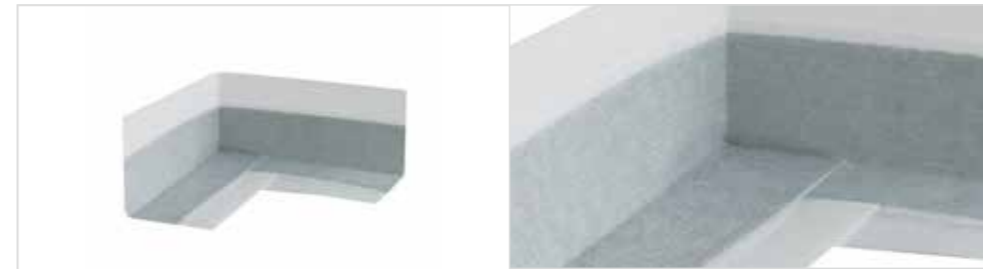

Art. no.	EAN code	Description
4506091	40 25345 05852 9	Internal Corner
5001050	0731628456671	External corner

**JACKOBOARD®**  
Collars

- For sealing passage holes for pipes through JACKOBOARD® construction elements in wet rooms

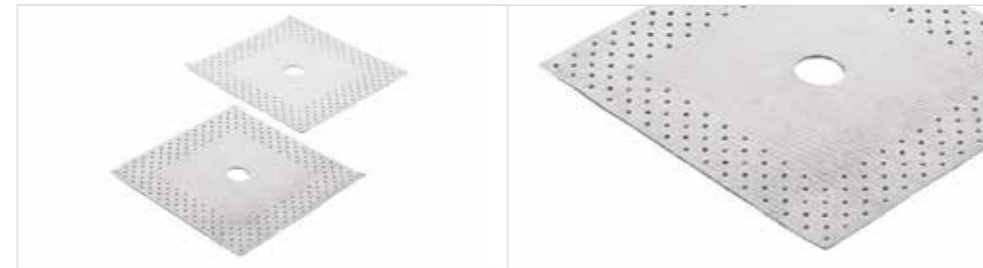

Art. no.	EAN code
4501725	40 25345 01725 0

**BOARD-FIX®**  
adhesive and  
sealing agent

- Special adhesive and sealing agent
- For gluing JACKODUR® and JACKOBOARD®
- One cartridge is sufficient for approximately 9 metres
- For furniture and bench seat construction in wet areas



Art. no.	EAN code	Volume ml
4506342	07 31628 45666 4	290

JACKOBOARD®  
Screws

- Includes screwdriver bit

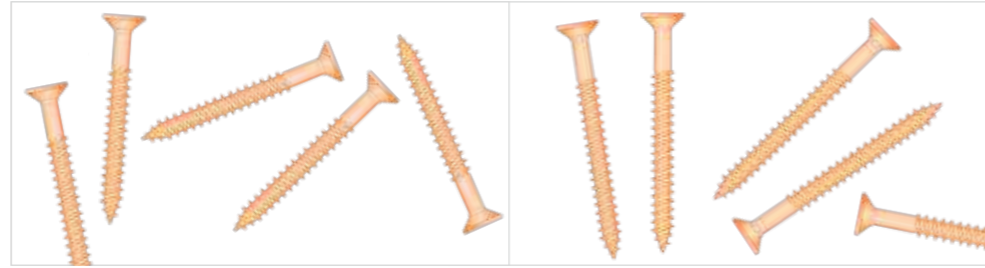

Art. no.	EAN code	Dimensions mm	Pcs./bag
5007000	0716053615053	4 x 25	200
5007010	0716053615060	4 x 35	200

JACKOBOARD®  
Plastic washers

- Plastic insulation board disk
- Dia. 36 mm



Art. no.	EAN code
5005100	40 25345 04509 3

JACKOBOARD®  
Galvanised Washers

- Galvanized insulation board disk
- 8 pcs/m<sup>2</sup>
- Internal dia. 4,8 mm



Art. no.	EAN code	Dimensions mm	Pcs./box
5005000	40 25345 00230 0	ø 36	100

JACKOBOARD®  
Stainless steel washers

- Stainless steel insulation board disk
- Dia. 36 mm
- Internal dia. 4,8 mm
- 8 pcs/m<sup>2</sup>

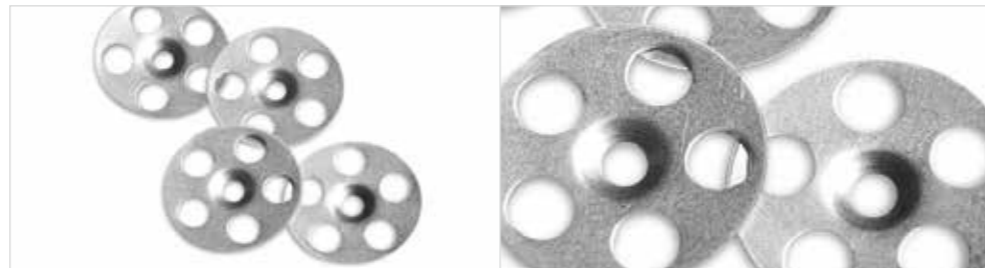

Art. no.	EAN code	Dimensions mm	Pcs./box
4501171	40 25345 01171 5	ø 36	100

JACKOBOARD®  
Anchor

- For fastening JACKOBOARD® Canto and JACKOBOARD® Plano and JACKOBOARD® Wabo



Art. no.	EAN code	inside measurement mm
4500036	40 25345 00036 8	2,0
4500015	40 25345 00015 3	3,0

JACKOBOARD®  
Metal disk plugs

- For securing JACKOBOARD® Plano to solid walls
- 5 pcs/m<sup>2</sup>
- Dowel hole ø 8 mm



Art. no.	EAN code	Dimensions mm	Pcs./box
4506483	40 25345 05855 0	50	20
4500164	40 25345 00164 8	80	20
4500530	40 25345 00530 1	110	10
4500165	40 25345 00165 5	140	10

Jackson H-Profile

- For joining together JACKOBOARD® Plano



Art. no.	EAN code	Dimensions mm	Pcs./box
4518940	40 25345 133608	50	2

Jackson U-Profile

- For securing JACKOBOARD® Plano



Art. no.	EAN code	Dimensions mm	Pcs./box
4518941	40 25345 133615	50	2

# Technical specifications

## JACKOBOARD® Plano

Properties	Standard	Unit	XPS core
Bulk density	EN 1602	kg/m <sup>3</sup>	> 30
Thermal conductivity $\lambda_D$	EN 13164	W/(m·K)	0,034 <sup>1)</sup>
Compressive strength and/or compressive stress at 10% compression	EN 826	N/mm <sup>2</sup>	> 0,30 <sup>2)</sup>
Dimensional stability at 70°C and 90% relative humidity	EN 1604	%	≤ 5
Deformation under 40 kPa load and 70°C temperature	EN 1605	%	≤ 5
Vapour diffusion resistance factor $\mu$ (dependent on the thickness)	EN 12086	-	200 - 60
Water absorption on long-term immersion	EN 12087	Vol-%	≤ 1
Linear thermal expansion coefficient	-	mm/(m·K)	0,07
Fire behaviour	EN 13501-1	Class	Euroclass E
Working temperature	-	°C	-50 /+75

Properties	Standard	Unit	JACKOBOARD® Plano	
Tensile strength	EN 1607	kPa	≥ 200	
Tolerances	Width	EN 822	mm	± 2
	Length	EN 822	mm	± 2
	Rectangularity	EN 824	mm/m	≤ 5
	Evenness	EN 825	mm	≤ 2
Edge profile	-	-	butt edge	

<sup>1)</sup> 80 mm  $\lambda_D = 0,035$  W/(m·K)

<sup>2)</sup> 0,2 N/mm<sup>2</sup> for Plano construction board 20 mm ≤ 20 mm

# Spares

At JACKOBOARD® we have a whole range of spare parts for various products, please enquire for more information.



## AQUA/AQUA FLAT

Art. no.	Description
4517250	Jackson standard grate (9)
4517242	odour trap seal (6)
4517237	odour trap - horizontal (6)
4517238	odour trap - vertical (6)
4517246	grate support frame (8)
4517247	back flow seal (7)
4517271	grate spacer (5)
4517272	tightening tool (4)
4517273	clamping ring (3)
4517274	lip seal
39211100	multistop for aqua

## AQUA LINE EASY

Art. no.	Description
4517236	odour trap
4517005	stainless steel grate - 300mm
4516656	stainless steel grate - 550mm
4516657	stainless steel grate - 750mm
39211101	multistop for aqua line easy or pro

## AQUA LINE PRO

Art. no.	Description
4517233	odour trap for aqua line pro
39211101	multistop for aqua line easy or pro

## ADAPTERS

Art. no.	Description
6000050	Reno DIN40 to BS1.5"
6000060	BS2" to BS1.5"

# Bespoke Colours +

We offer a wide range of colour variations for some of our popular grates. These are highlighted in the catalogue using the symbol above. Please enquire for more details.

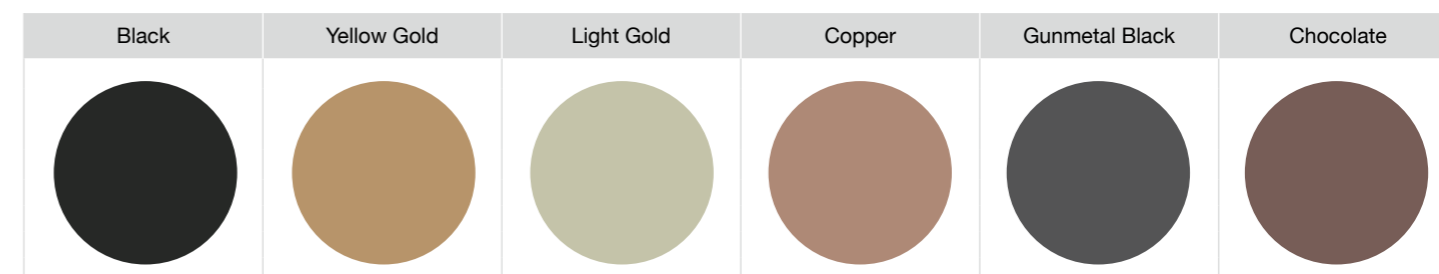

Pictures shown are for illustration purposes only. Actual product colour may vary slightly from image shown.

✓ JACKOBOARD® Aqua shower element

Properties	Unit	Value
Compressive strength at 10% compression according to EN 826 (XPS core)	kPa	> 300
Tensile strength	kPa	> 200
Fall	-	integrated
Thickness	mm	20, 25, 40, 50
Minimum tile size	mm	25 x 25 x 4 <sup>1)</sup>
Wheelchair accessible from tile size	mm	50 x 50 x 6,5
Fire behaviour	-	Euroclass E
Thermal conductivity ( $\lambda_D$ ) according to EN 13164 (XPS core)	W/(m·K)	0,034

<sup>1)</sup> For smaller tile sizes the joints must be grouted with epoxy resin grout.

✓ Horizontal drain (Art. no. 4512007)

Properties	Unit	Value
Drainage rate	l/s	0,9
Installation height	mm	77
Water trap height	mm	50 <sup>2)</sup>
Grate load class	-	K3
Pipe connection	-	DN 50
Grate size	mm	120 x 120 x 4
Grate frame size	mm	130 x 130 x 9
Tile thickness incl. plaster	mm	3-38

<sup>2)</sup> Installation height incl. shower element up to 97 mm

✓ Vertical drain (Art. no. 4512008)

Properties	Unit	Value
Drainage rate	l/s	0,9
Installation height	mm	115 <sup>3)</sup>
Water trap height	mm	50
Grate load class	-	K3
Pipe connection	-	DN 40 and DN 50
Grate size	mm	120 x 120 x 4
Grate frame size	mm	130 x 130 x 9
Tile thickness incl. plaster	mm	3-38

<sup>3)</sup> Floor drain underside (without drain nozzle)

We would like to point out that the data, images, technical information and drawings provided in the brochure are general details and only constitute suggestions. The illustrations are schematic and demonstrate the basic functional principle. Exact dimensions are not specified. The fabricator/customer is responsible for testing the applicability with regard to the respective construction project. All specifications and data must be adapted to local conditions and do not constitute construction, detail or installation documentation. The technical specifications and data for the products in the data sheets and system descriptions/approvals must be observed.



**JACKON UK Limited**  
Unit 5 Ormside Close  
Hindley Industrial Estate  
Hindley Green  
Wigan  
WN2 4HR

Tel: +44 (0)1204 221089  
E-Mail: [info@jackon.co.uk](mailto:info@jackon.co.uk)  
[www.jackon.co.uk](http://www.jackon.co.uk)

Your dealer:

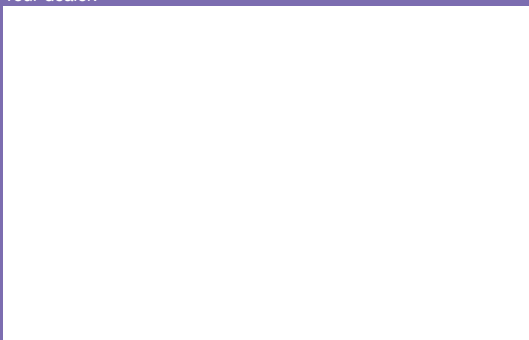

Reg.-Nr.067674

